

受電  
3φ3W 6600V 50Hz

構内1号柱

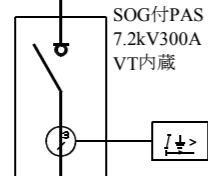

6kV EM-CET38Sq

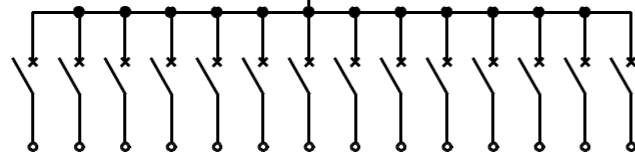
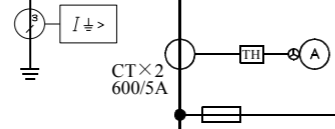
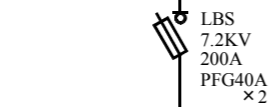

負荷名称	幹線サイズ	配線用遮断器
農場電灯	CVT160Sq	MCCB 3P 100AF/100AT
農場管理舎電灯	CVT138Sq	MCCB 3P 100AF/100AT
本館電灯	CVT138Sq	MCCB 3P 225AF/225AT
A-4 系統	CV60Sq-3C	MCCB 3P 225AF/225AT
附属建家	CV14Sq-3C	MCCB 3P 100AF/100AT
不明	WF2Sq-2C	MCCB 3P 50AF/50AT
火災報知 (受信器)	CV14Sq-2C	MCCB 3P 50AF/50AT
展示温室電灯	CVT138Sq	MCCB 3P 100AF/100AT
A-2 系統	CV60Sq-3C	MCCB 3P 225AF/225AT
A-3 系統	CV60Sq-3C	MCCB 3P 225AF/225AT
展示温室 (研修室)	CVT138Sq	MCCB 3P 100AF/100AT
PL-9 電灯	CVT138Sq	MCCB 3P 100AF/100AT
予備		MCCB 3P 100AF/50AT
予備		MCCB 3P 100AF/100AT

低圧電灯盤

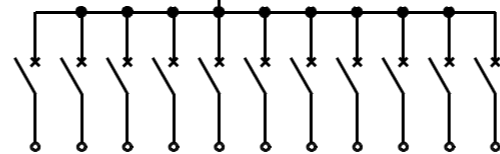
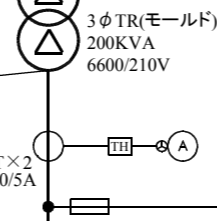
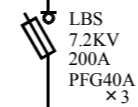
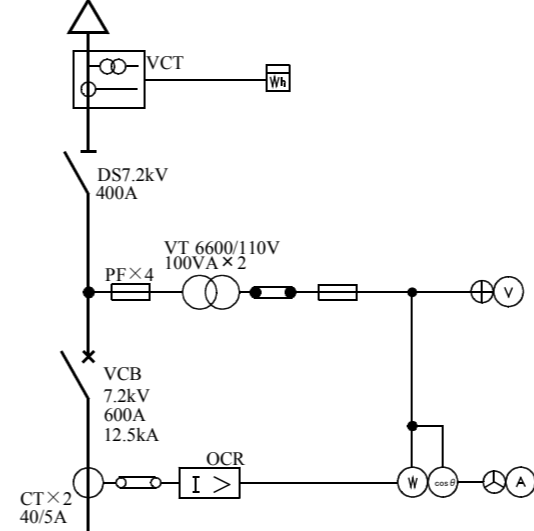

負荷名称	幹線サイズ	配線用遮断器
本館動力	CVT138Sq	MCCB 3P 225AF/125AT
PL-9 動力	CVT138Sq	MCCB 3P 100AF/75AT
M-3 (ヒーター)	CV22Sq-2C	MCCB 3P 225AF/225AT
M-3 動力盤	CVT138Sq	MCCB 3P 225AF/200AT
展示温室	CVT150Sq	MCCB 3P 200AT
フラン舎排水ポンプ	CV22Sq-2C	MCCB 3P 225AF/225AT
温室	CV14Sq-2C	MCCB 3P 225AF/200AT
農場動力	CVT14Sq	MCCB 3P 100AF/50AT
展示温室動力	CVT160Sq	MCCB 3P 200AT
予備		MCCB 3P 100AF/100AT
予備		MCCB 3P 100AF/100AT

低圧動力盤

